



GaAs pHEMPT MMIC 0.5 Watt POWER AMPLIFIER 33.5 - 46.5 GHz

Typical Applications

The HMC1014 is ideal for:

- Point-to-Point Radios
- Point-to-Multi-Point Radios
- VSAT & SATCOM
- Military & Space

Features

- P1dB Output Power: +24.5 dBm
- Psat Output Power: +27.5 dBm
- High Gain: 21 dB
- Output IP3: +35 dBm
- Supply Voltage: Vdd = +6V @ 500 mA
- 50 Ohm Matched Input/Output
- Die Size: 2.76 x 1.6 x 0.1 mm

Functional Diagram

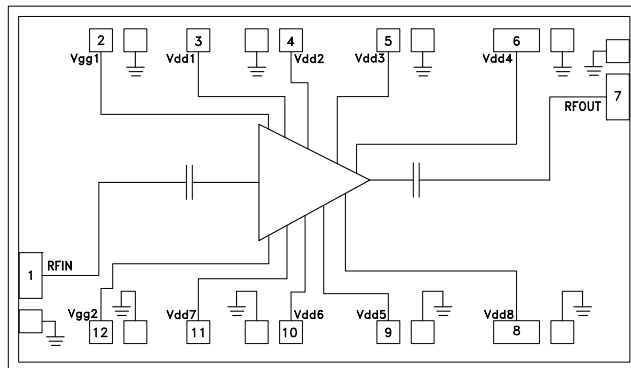

General Description

The HMC1014 is a four stage GaAs pHEMPT MMIC Medium Power Amplifier die which operates between 33.5 and 46.5 GHz. The amplifier provides 21 dB of gain, +27.5 dBm of saturated output power, and 27% PAE from a +6V supply. With up to +35 dBm OIP3 the HMC1014 is ideal for high linearity applications in military and space as well as point-to-point and point-to-multi-point radios. The HMC1014 amplifier I/Os are internally matched facilitating integration into multi-chip-modules (MCMs). All data shown herein was measured with the chip connected via two 0.025 mm (1 mil) wire bonds of minimal length 0.31 mm (12 mils).

Electrical Specifications, $T_A = +25^\circ\text{C}$, $V_{dd1} - V_{dd8} = +6\text{V}$, $I_{dd} = 500\text{ mA}$ [1]

Parameter	Min.	Typ.	Max.	Min.	Typ.	Max.	Units
Frequency Range		33.5 - 43		43 - 46.5			GHz
Gain	18	21		18	21		dB
Gain Variation Over Temperature		0.029			0.035		dB/ °C
Input Return Loss		25			32		dB
Output Return Loss		18			17		dB
Output Power for 1 dB Compression (P1dB)	22	24.5		21	23.5		dBm
Saturated Output Power (Psat)		27.5			26.5		dBm
Output Third Order Intercept (IP3) [2]		35			34		dBm
Total Supply Current		500			500		mA

[1] Adjust Vgg between -2 to 0V to achieve Idd = 500 mA typical.

[2] Measurement taken at Pout / tone = +15 dBm.

GaAs pHEMPT MMIC 0.5 Watt POWER AMPLIFIER 33.5 - 46.5 GHz

Gain & Return Loss

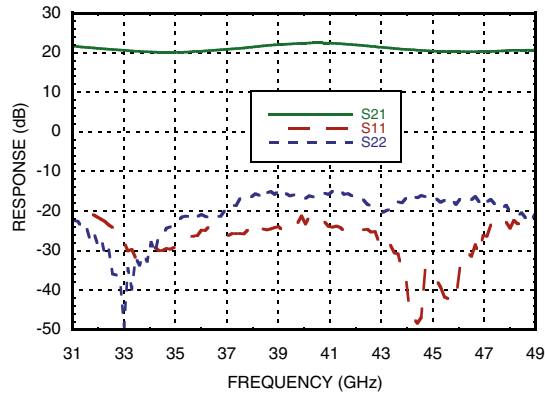

Gain vs. Temperature

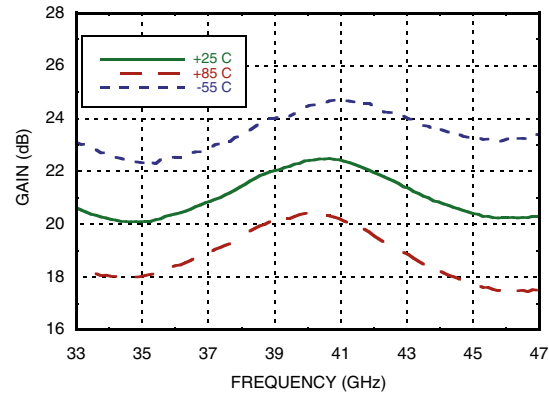

Input Return Loss vs. Temperature

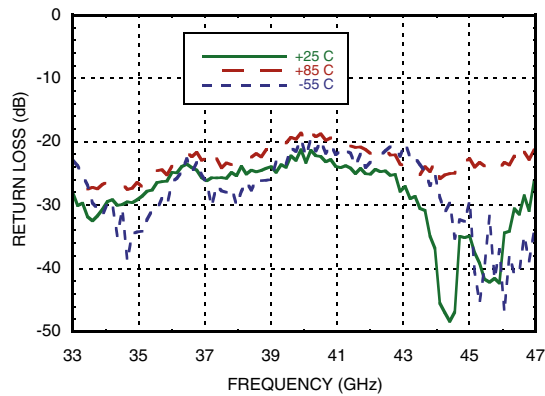

Output Return Loss vs. Temperature

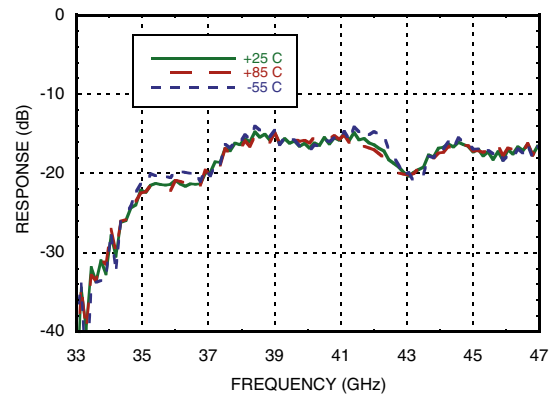

P1dB vs. Temperature

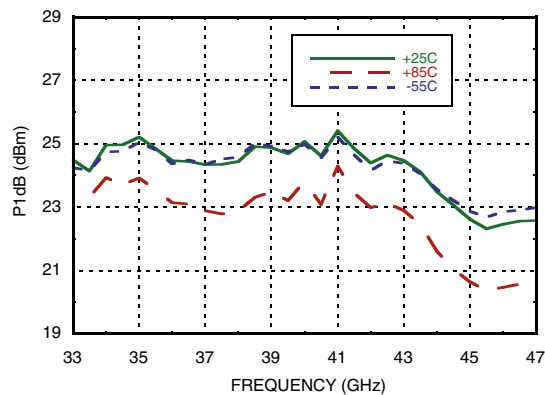

P1dB vs. Supply Voltage

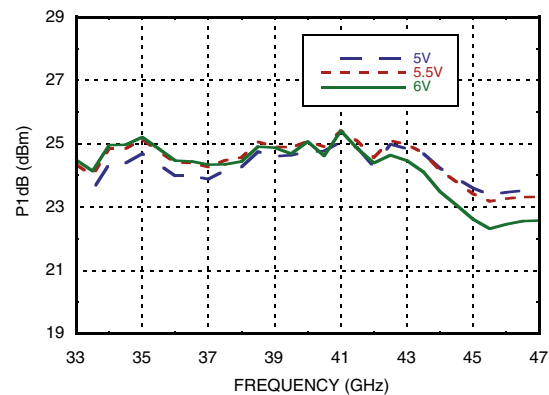



**GaAs pHEMPT MMIC 0.5 Watt
POWER AMPLIFIER 33.5 - 46.5 GHz**

AMPLIFIERS - LINEAR & POWER - CHIP

Psat vs. Temperature

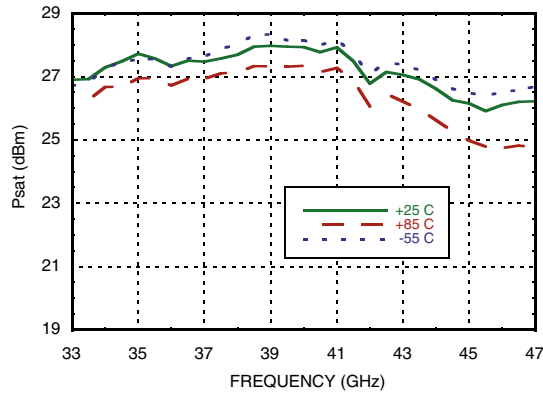

Psat vs. Supply Voltage

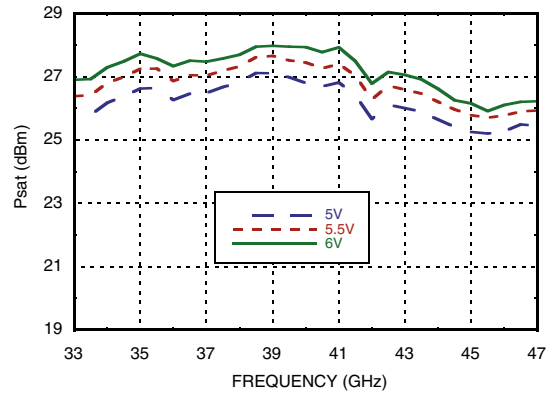

P1dB vs. Supply Current

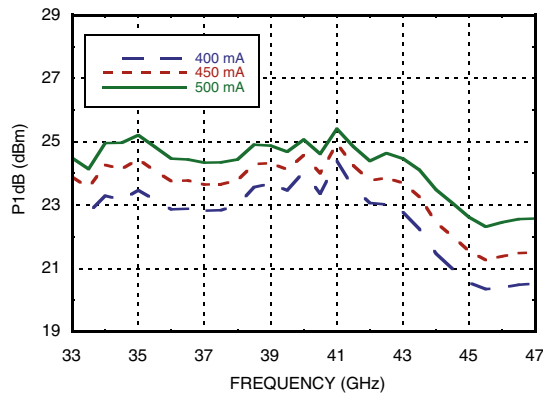

Psat vs. Supply Current

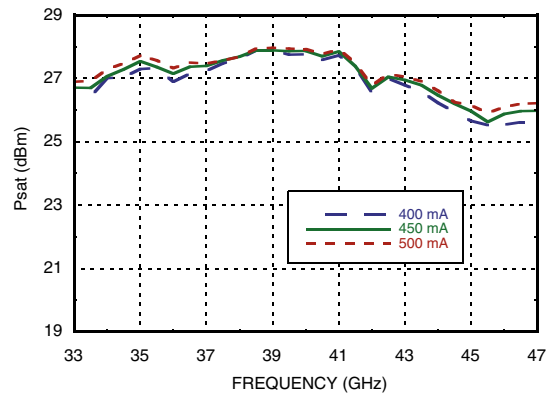

**Output IP3 vs. Temperature,
Pout/tone = +15 dBm**

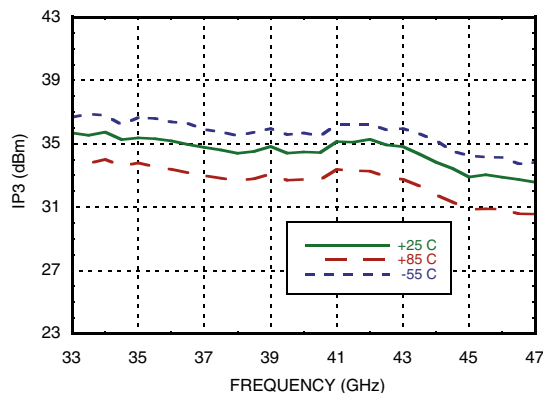

**Output IP3 vs. Supply Current,
Pout/tone = +15 dBm**

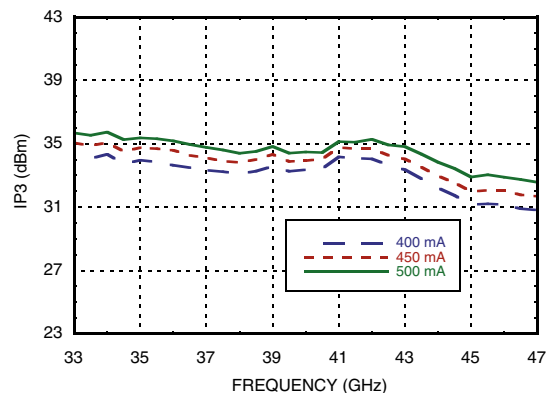



**GaAs pHEMPT MMIC 0.5 Watt
POWER AMPLIFIER 33.5 - 46.5 GHz**

**Output IP3 vs. Supply Voltage,
Pout/tone = +15 dBm**

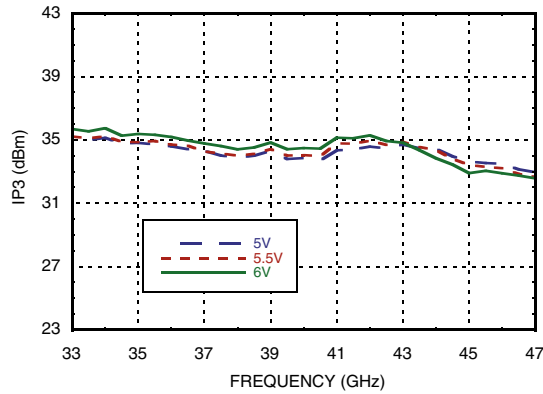

Output IM3 @ Vdd = +5V

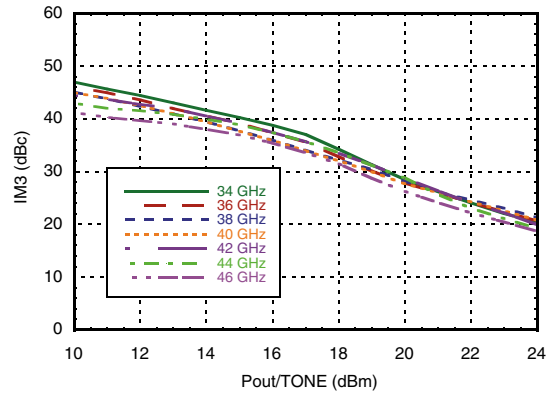

Output IM3 @ Vdd = +5.5V

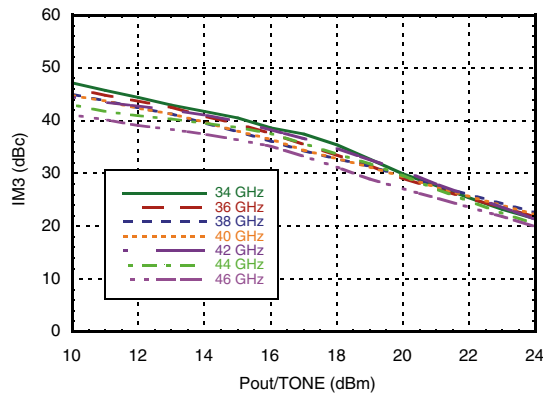

Output IM3 @ Vdd = +6V

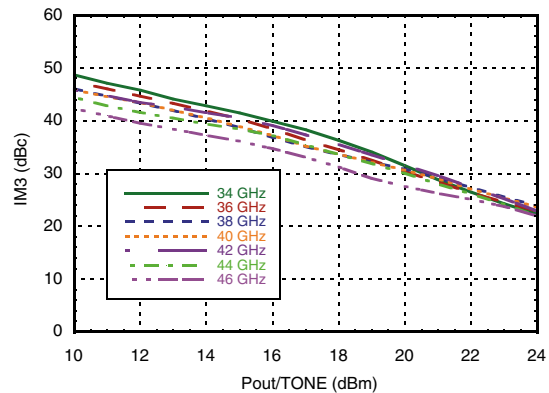

Power Compression @ 34 GHz

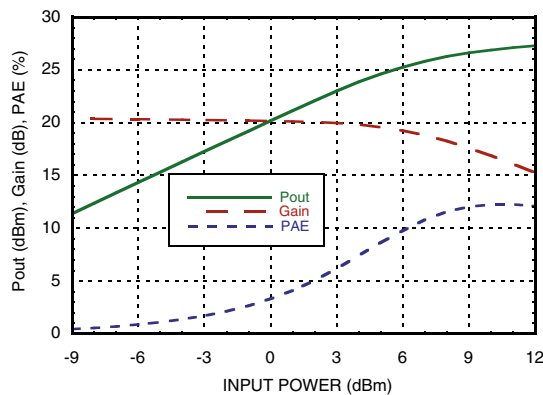

Power Compression @ 40 GHz

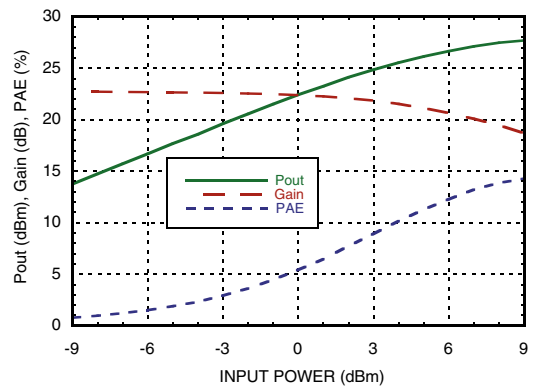



**GaAs pHEMPT MMIC 0.5 Watt
POWER AMPLIFIER 33.5 - 46.5 GHz**

Power Compression @ 46 GHz

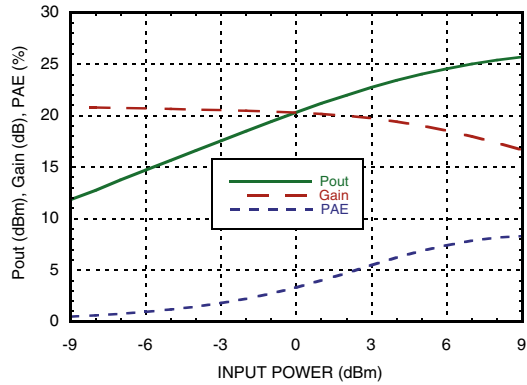

**Gain & Power vs.
Supply Current @ 40 GHz**

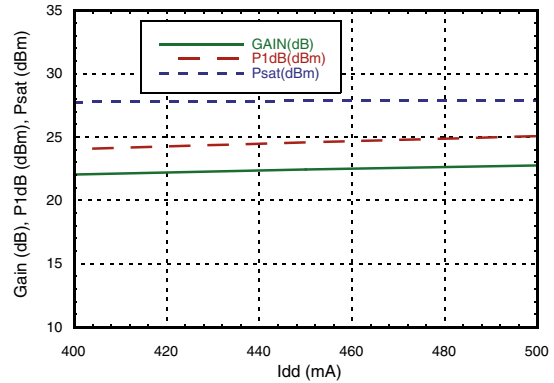

**Gain & Power vs.
Supply Voltage @ 40 GHz**

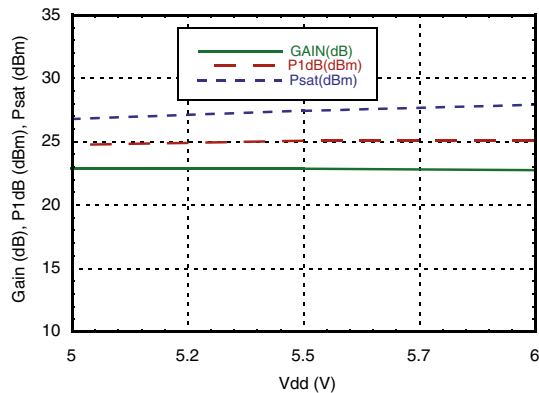

Reverse Isolation vs. Temperature

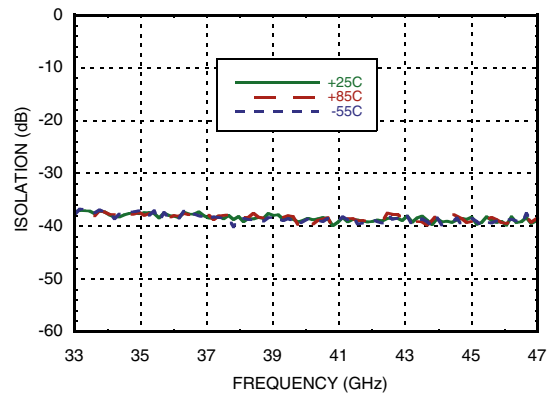

Power Dissipation

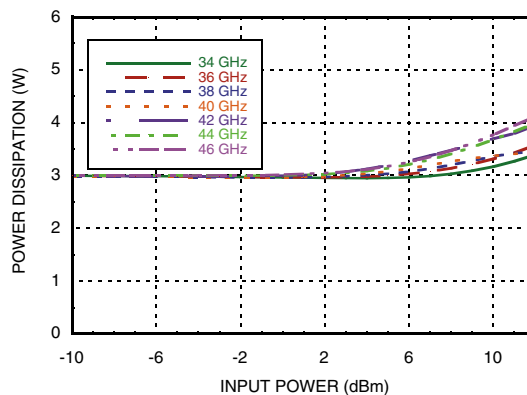



**GaAs pHEMPT MMIC 0.5 Watt
POWER AMPLIFIER 33.5 - 46.5 GHz**

Absolute Maximum Ratings

Drain Bias Voltage (Vdd)	+7 Vdc
RF Input Power (RFIN)	+18 dBm
Channel Temperature	150 °C
Continuous Pdiss (T= 85 °C) (derate 48.3 mW/°C above 85 °C)	3.14 W
Thermal Resistance (channel to die bottom)	20.7 °C/W
Storage Temperature	-65 to 150°C
Operating Temperature	-55 to 85 °C

Typical Supply Current vs. Vdd

Vdd (V)	Idd (mA)
+5	500
+5.5	500
+6	500



ELECTROSTATIC SENSITIVE DEVICE
OBSERVE HANDLING PRECAUTIONS

Outline Drawing

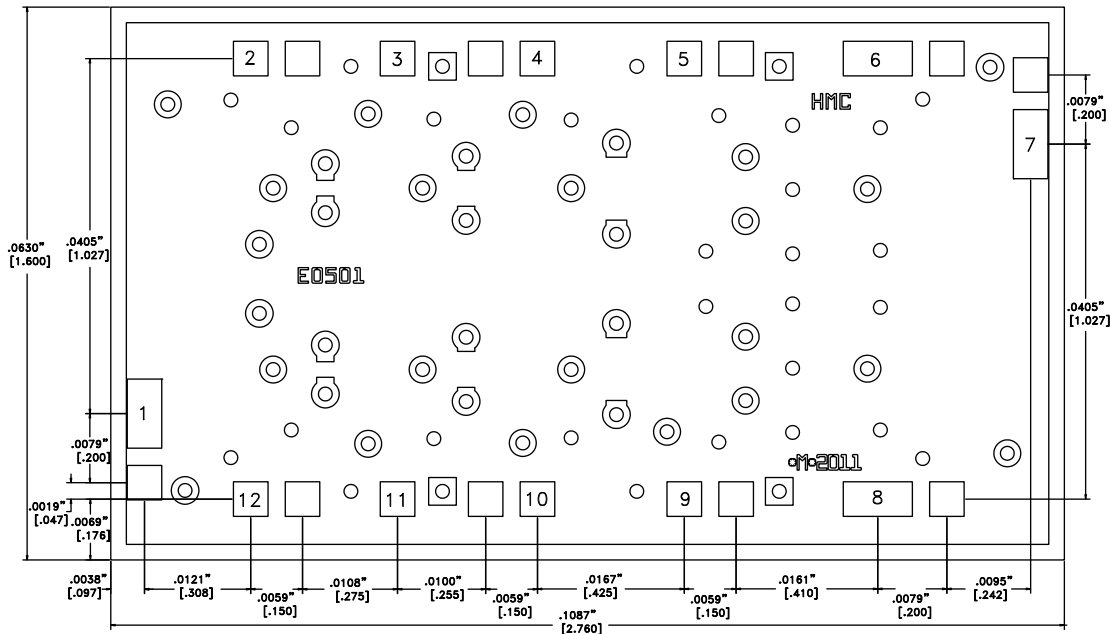

- NOTES:
1. ALL DIMENSIONS ARE IN INCHES [MM]
 2. DIE THICKNESS IS .004"
 3. TYPICAL BOND PAD IS .004" SQUARE
 4. BACKSIDE METALLIZATION: GOLD
 5. BOND PAD METALLIZATION: GOLD
 6. BACKSIDE METAL IS GROUND.
 7. CONNECTION NOT REQUIRED FOR UNLABELED BOND PADS.
 8. OVERALL DIE SIZE ± .002

Die Packaging Information [1]

Standard	Alternate
GP-1 (Gel Pack)	[2]



[1] Refer to the "Packaging Information" section for die packaging dimensions.

[2] For alternate packaging information contact Hittite Microwave Corporation.

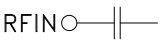
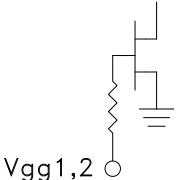
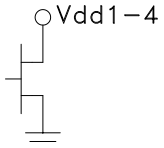
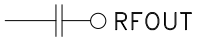
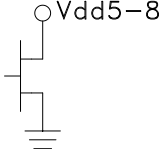

GaAs pHEMPT MMIC 0.5 Watt POWER AMPLIFIER 33.5 - 46.5 GHz

Pin Descriptions

Pin Number	Function	Description	Interface Schematic
1	RFIN	RF signal input. This pin is AC coupled and matched to 50 Ohms over the operating frequency range.	
2, 12	Vgg1, Vgg2	Gate control for amplifier. Amplifier can be biased by either Vgg1 or Vgg2. External bypass capacitors of 100 pF, 0.01uF, and 4.7 uF capacitors are required.	
3, 4, 5, 6	Vdd1-4	Drain bias voltage for the top half of the amplifier. External bypass capacitors of 100 pF required for each pin, followed by common 0.01uF and 4.7 uF Capacitors	
7	RFOUT	RF signal output. This pad is AC coupled and matched to 50 Ohms over the operating frequency range.	
8, 9, 10, 11	Vdd5-8	Drain bias voltage for the bottom half of the amplifier. External bypass capacitors of 100 pF required for each pin followed by common 0.01 uF and 4.7 uF capacitors.	
Die Bottom	GND	Die bottom must be connected to RF/DC ground.	

Application Circuit

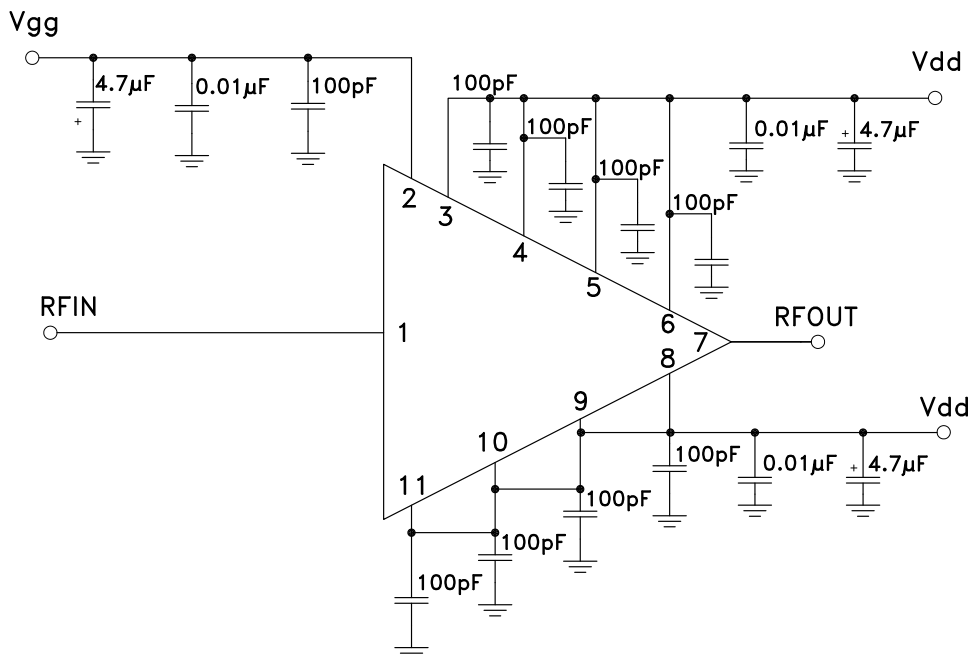

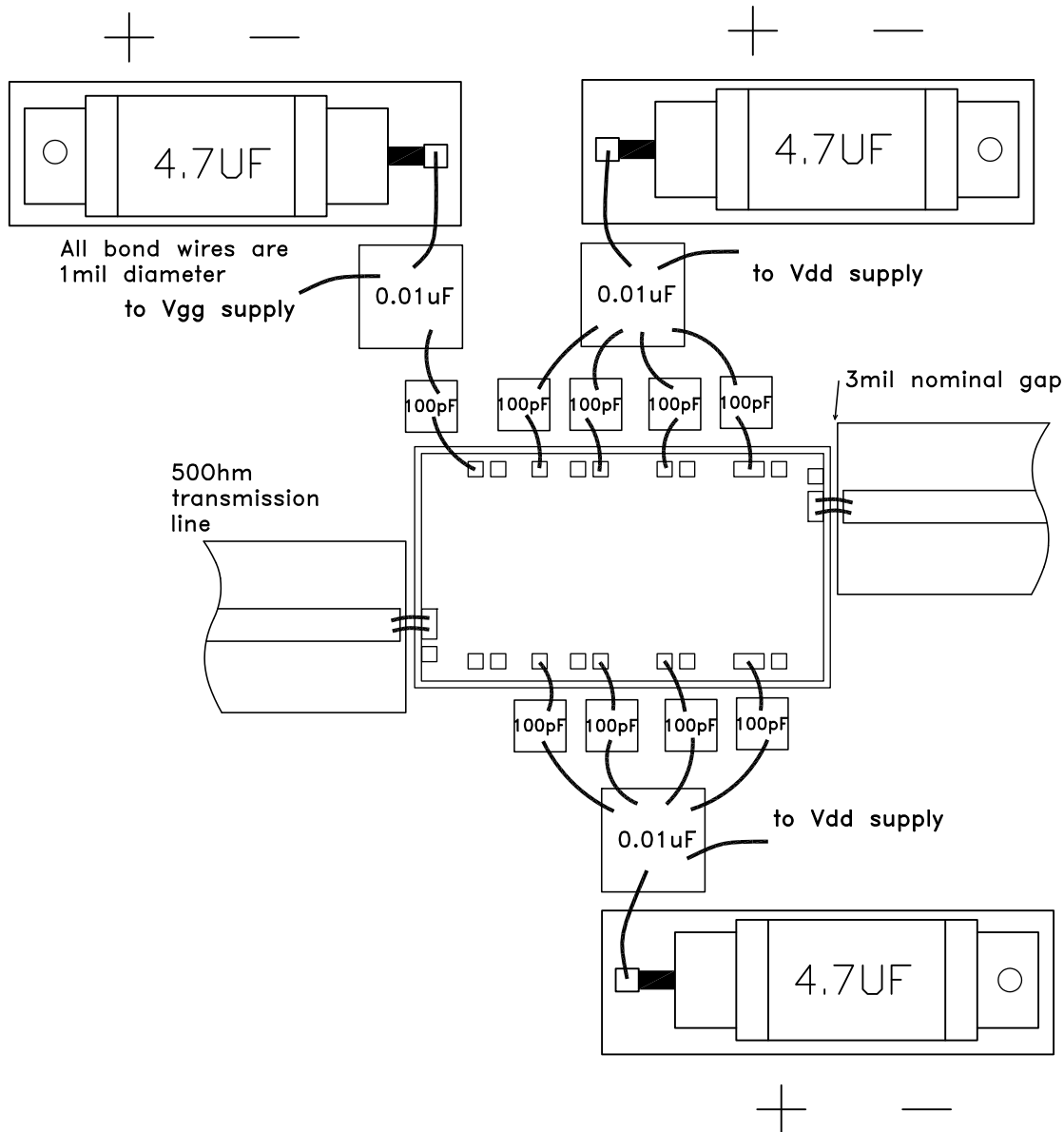
**GaAs pHEMPT MMIC 0.5 Watt
POWER AMPLIFIER 33.5 - 46.5 GHz**
Assembly Diagram



GaAs pHEMPT MMIC 0.5 Watt POWER AMPLIFIER 33.5 - 46.5 GHz

Mounting & Bonding Techniques for Millimeterwave GaAs MMICs

The die should be attached directly to the ground plane eutectically or with conductive epoxy (see HMC general Handling, Mounting, Bonding Note).

50 Ohm Microstrip transmission lines on 0.127mm (5 mil) thick alumina thin film substrates are recommended for bringing RF to and from the chip (Figure 1). If 0.254mm (10 mil) thick alumina thin film substrates must be used, the die should be raised 0.150mm (6 mils) so that the surface of the die is coplanar with the surface of the substrate. One way to accomplish this is to attach the 0.102mm (4 mil) thick die to a 0.150mm (6 mil) thick molybdenum heat spreader (moly-tab) which is then attached to the ground plane (Figure 2).

Microstrip substrates should be located as close to the die as possible in order to minimize bond wire length. Typical die-to-substrate spacing is 0.076mm to 0.152 mm (3 to 6 mils).

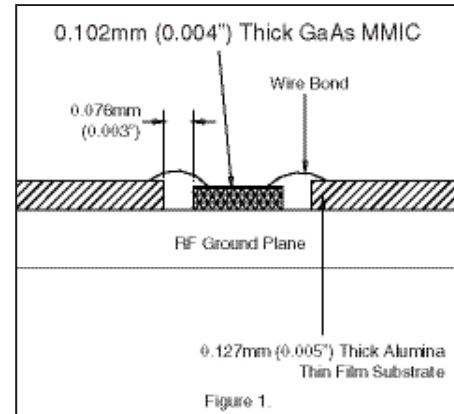

Handling Precautions

Follow these precautions to avoid permanent damage.

Storage: All bare die are placed in either Waffle or Gel based ESD protective containers, and then sealed in an ESD protective bag for shipment. Once the sealed ESD protective bag has been opened, all die should be stored in a dry nitrogen environment.

Cleanliness: Handle the chips in a clean environment. DO NOT attempt to clean the chip using liquid cleaning systems.

Static Sensitivity: Follow ESD precautions to protect against > ± 250V ESD strikes.

Transients: Suppress instrument and bias supply transients while bias is applied. Use shielded signal and bias cables to minimize inductive pick-up.

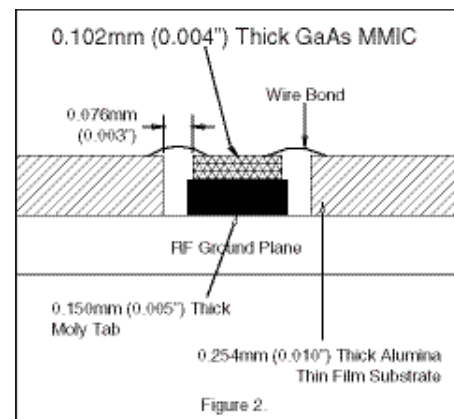

General Handling: Handle the chip along the edges with a vacuum collet or with a sharp pair of bent tweezers. The surface of the chip may have fragile air bridges and should not be touched with vacuum collet, tweezers, or fingers.

Mounting

The chip is back-metallized and can be die mounted with AuSn eutectic preforms or with electrically conductive epoxy. The mounting surface should be clean and flat.

Eutectic Die Attach: A 80/20 gold tin preform is recommended with a work surface temperature of 255 °C and a tool temperature of 265 °C. When hot 90/10 nitrogen/hydrogen gas is applied, tool tip temperature should be 290 °C. DO NOT expose the chip to a temperature greater than 320 °C for more than 20 seconds. No more than 3 seconds of scrubbing should be required for attachment.

Epoxy Die Attach: Apply a minimum amount of epoxy to the mounting surface so that a thin epoxy fillet is observed around the perimeter of the chip once it is placed into position. Cure epoxy per the manufacturer's schedule.

Wire Bonding

Ball or wedge bond with 0.025mm (1 mil) diameter pure gold wire. Thermosonic wirebonding with a nominal stage temperature of 150 °C and a ball bonding force of 40 to 50 grams or wedge bonding force of 18 to 22 grams is recommended. Use the minimum level of ultrasonic energy to achieve reliable wirebonds. Wirebonds should be started on



**GaAs pHEMPT MMIC 0.5 Watt
POWER AMPLIFIER 33.5 - 46.5 GHz**

Notes: